



## RX-8130

### Ergo™ Micro-Bevel® Precision Cut Diagonal Cutter with Oval Head 0.2-1 mm







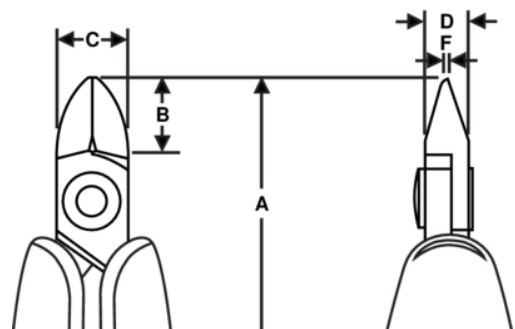

## PRODUCT DETAILS

- Ideal for cutting leads, jewelry wire, and general assembly applications
- Two-component ESD safe Ergo™ handles: Thermoplastic surface on tough polypropylene provides superior grip
- Material: High performance alloy steel
- Precision induction hardened cutting edges 63–65 HRC
- Micro-Touch™: The shape of the handles makes it possible to control and rotate the pliers between thumb and index finger for precision work
- Precision screw joint minimizes friction and maximizes alignment of cutting edges
- Biospring® reduces tension throughout the working cycle of the tool and can be adjusted in three different positions
- Cutting capacity is listed for solid copper wire
- Burnished finish



PRODUCT ATTRIBUTES

Product: **RX-8130**

	Oval		XS	<b>A</b>	133.5 mm
<b>A</b>	5.25 in	<b>B</b>	8,5 mm	<b>B</b>	0,33 in
<b>C</b>	8 mm	<b>C</b>	0.31 in	<b>D</b>	5 mm
<b>D</b>	0,2 inch	<b>F</b>	0,8 mm	<b>F</b>	0,03 in
	0.2-1.0 mm		0.00 - 0.04 in		Micro-Bevel ®
	68 g	<b>Ω</b>	Dissipative		