



RX-8150

Ergo™ Micro-Bevel® Precision Cut Diagonal Cutter with Oval Head 0.3-1.6 mm







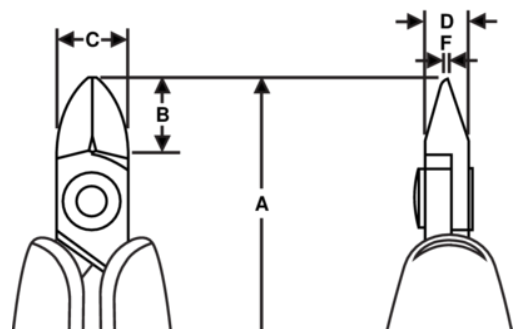

PRODUCT DETAILS

- Ideal for cutting leads, jewelry wire, and general assembly applications
- Two-component ESD safe Ergo™ handles: Thermoplastic surface on tough polypropylene provides superior grip
- Material: High performance alloy steel
- Precision induction hardened cutting edges 63–65 HRC
- Micro-Touch™: The shape of the handles makes it possible to control and rotate the pliers between thumb and index finger for precision work
- Precision screw joint minimizes friction and maximizes alignment of cutting edges
- Biospring® reduces tension throughout the working cycle of the tool and can be adjusted in three different positions
- Cutting capacity is listed for solid copper wire
- Burnished finish



PRODUCT ATTRIBUTES

Product: **RX-8150**

	Oval		M	A	138.0 mm
A	5.43 in	B	13 mm	B	0,51 in
C	12,5 mm	C	0.49 in	D	6 mm
D	0,24 inch	F	1,2 mm	F	0,05 in
	0.3-1.6 mm		0.01-0.06 in		Micro-Bevel ®
	73 g	Ω	Dissipative		