



RX-8161

Ergo™ Flush Precision Cut Diagonal Cutter with Oval Head 0.3-2 mm







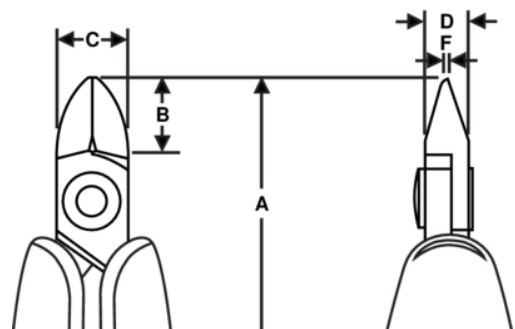

PRODUCT DETAILS

- Ideal for cutting leads, jewelry wire, and general assembly applications
- Two-component ESD safe Ergo™ handles: Thermoplastic surface on tough polypropylene provides superior grip
- Material: High performance alloy steel
- Precision induction hardened cutting edges 63–65 HRC
- Micro-Touch™: The shape of the handles makes it possible to control and rotate the pliers between thumb and index finger for precision work
- Precision screw joint minimizes friction and maximizes alignment of cutting edges
- Biospring® reduces tension throughout the working cycle of the tool and can be adjusted in three different positions
- Cutting capacity is listed for solid copper wire
- Burnished finish



PRODUCT ATTRIBUTES

Product: **RX-8161**

	Oval		L	A	147.0 mm
A	5.80 in	B	16 mm	B	0,63 in
C	16 mm	C	0.63 in	D	8 mm
D	0,31 inch	F	1,6 mm	F	0,06 in
	0.3-2.0 mm		0.01 - 0.08 in		Flush
	97 g	Ω	Dissipative		