



8146

**Micro-Bevel® Precision Cut
Diagonal Cutter with Tapered &
Relieved Head & ESD Safe Handle
0.2-1 mm**







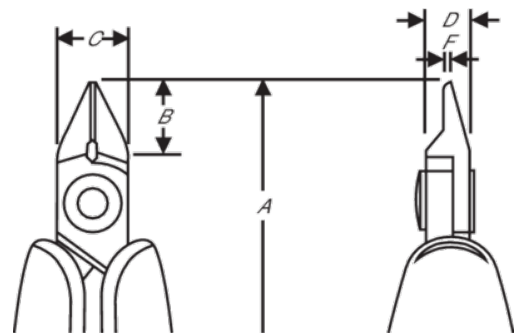

PRODUCT DETAILS

- Material: High performance alloy steel
- Exacting induction hardened edges 63–65 HRC
- ESD safe handles in synthetic material with leaf springs
- Precision screw joint that minimizes friction and maximizes alignment of cutting edges
- Cutting capacity is listed for solid copper wire



PRODUCT ATTRIBUTES

Product: **8146**

	Tapered & Relieved		S		Micro-Bevel®
	0.2-1.0 mm		0.01-0.04 in	A	110.5 mm
A	4.33 in	B	10 mm	B	0,39 in
C	10 mm	C	0.39 in	D	6 mm
D	0,24 inch	F	0,8 mm	F	0,03 in
	46 g	Ω	Dissipative		