



**8148**

**Ultra-Flush® Precision Cut  
Diagonal Cutter with Tapered &  
Relieved Head & ESD Safe Handle  
0.1-0.8 mm**







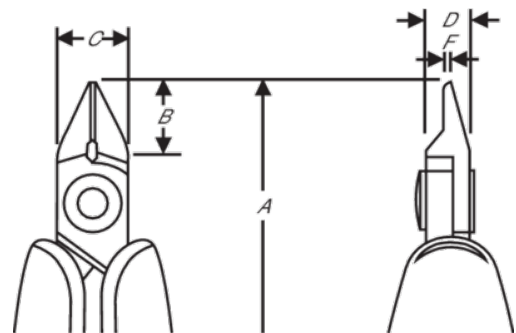

## PRODUCT DETAILS

- Material: High performance alloy steel
- Exacting induction hardened edges 63–65 HRC
- ESD safe handles in synthetic material with leaf springs
- Precision screw joint that minimizes friction and maximizes alignment of cutting edges
- Cutting capacity is listed for solid copper wire



PRODUCT ATTRIBUTES

Product: **8148**

	Tapered & Relieved		S		Ultra-Flush®
	0.1-0.8 mm		0.00-0.03 in	<b>A</b>	110.5 mm
<b>A</b>	4.33 in	<b>B</b>	10 mm	<b>B</b>	0,39 in
<b>C</b>	10 mm	<b>C</b>	0.39 in	<b>D</b>	6 mm
<b>D</b>	0,24 inch	<b>F</b>	0,8 mm	<b>F</b>	0,03 in
	45 g	<b>Ω</b>	Dissipative		